

DAILY REFERENCE GUIDE



THANK YOU FOR PURCHASING A WHIRLPOOL PRODUCT

To receive more comprehensive help and support, please register your product at www.whirlpool.eu/register



You can download the Safety Instructions and the Use and Care Guide by visiting our website docs.whirlpool.eu and following the instructions on the back of this booklet.



Before using the appliance carefully read the Health and Safety guide.

PRODUCT DESCRIPTION

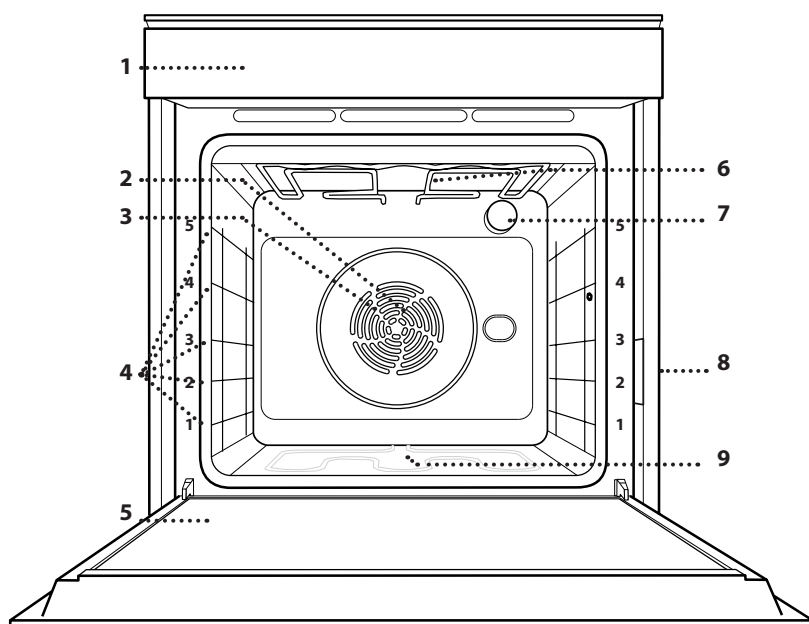

1. Control panel
2. Fan
3. Circular heating element (not visible)
4. Shelf guides (the level is indicated on the front of the oven)
5. Door
6. Upper heating element/grill
7. Lamp
8. Identification plate (do not remove)
9. Lower heating element (not visible)

CONTROL PANEL DESCRIPTION

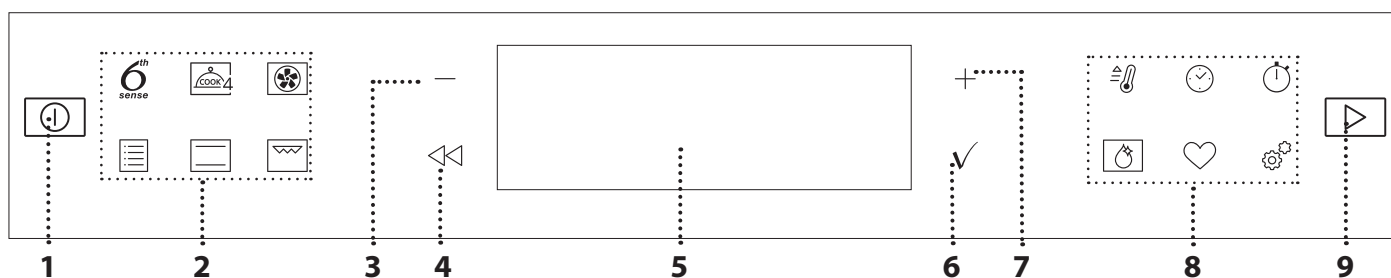

1. ON / OFF

For switching the oven on and off and for stopping an active function.

2. FUNCTIONS DIRECT ACCESS

For quick access to the functions and menu.

3. NAVIGATION BUTTON MINUS

For scrolling through a menu and decreasing the settings or values of a function.

4. BACK

For returning to the previous screen. During cooking, allows settings to be changed.

5. DISPLAY

For immediately starting a function.

6. CONFIRM

For confirming a selected function or a set value.

7. NAVIGATION BUTTON PLUS

For scrolling through a menu and increasing the settings or values of a function.

8. OPTIONS / FUNCTIONS DIRECT ACCESS

For quick access to the functions, duration, settings and favorites.

9. START

For starting a function using the specified or basic settings.

ACCESSORIES

WIRE SHELF

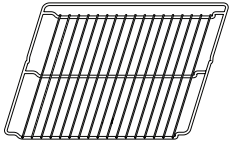

Use to cook food or as a support for pans, cake tins and other ovenproof items of cookware

DRIP TRAY

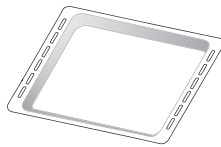

Use as an oven tray for cooking meat, fish, vegetables, focaccia, etc. or position underneath the wire shelf to collect cooking juices.

BAKING TRAY

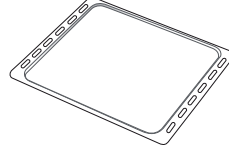

Use for cooking all bread and pastry products, but also for roasts, fish en papillote, etc.

SLIDING RUNNERS *

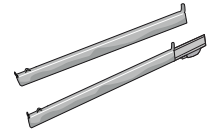

To facilitate inserting or removing accessories.

* Available only on certain models

The number and the type of accessories may vary depending on which model is purchased.

Other accessories can be purchased separately from the After-sales Service.

INSERTING THE WIRE SHELF AND OTHER ACCESSORIES

Insert the wire shelf horizontally by sliding it across the shelf guides, making sure that the side with the raised edge is facing upwards.

Other accessories, such as the drip tray and the baking tray, are inserted horizontally in the same way as the wire shelf.

REMOVING AND REFITTING THE SHELF GUIDES

- To remove the shelf guides, lift the guides up and then gently pull the lower part out of its seating: The shelf guides can now be removed.
- To refit the shelf guides, first fit them back into their upper seating. Keeping them held up, slide them into the cooking compartment, then lower them into position in the lower seating.

FITTING THE SLIDING RUNNERS (IF PRESENT)

Remove the shelf guides from the oven and remove the protective plastic from the sliding runners.

Fasten the upper clip of the runner to the shelf guide and slide it along as far as it will go. Lower the other clip into position. To secure the guide, press the lower portion of the clip firmly against the shelf guide. Make sure that the runners can move freely. Repeat these steps on the other shelf guide on the same level.

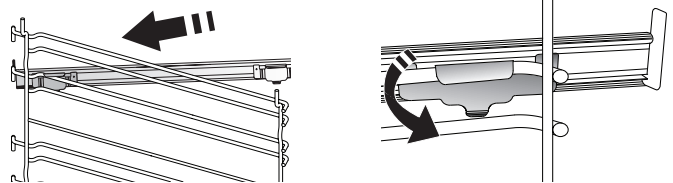

Please note: The sliding runners can be fitted on any level.

FUNCTIONS



6th SENSE

These allow a fully automatic cooking for all types of food (Lasagna, Meat, Fish, Vegetables, Cakes & Pastries, Salt cakes, Bread, Pizza).

To get the best from this function, follow the indications on the relative cooking table.



COOK 4 FUNCTIONS

For cooking different foods that require the same cooking temperature on four levels at the same time. This function can be used to cook cookies, cakes, round pizzas (also frozen) and to prepare a complete meal. Follow the cooking table to obtain the best results.



FORCED AIR

For cooking different foods that require the same cooking temperature on several shelves (maximum three) at the same time. This function can be used to cook different foods without odours being transferred from one food to another.



TRADITIONAL FUNCTIONS

• CONVECTION BAKE

For cooking meat, baking cakes with fillings on one shelf only.

• TURBO GRILL

For roasting large joints of meat (legs, roast beef, chicken). We recommend using a drip tray to collect the cooking juices: Position the pan on any of the levels below the wire shelf and add 500 ml of drinking water.

• FROZEN BAKE

The function automatically selects the ideal cooking temperature and mode for 5 different types of ready frozen food. The oven does not have to be preheated.

• SPECIAL FUNCTIONS

» MAXI COOKING

The function automatically selects the best cooking mode and temperature to cook large joints of meat (above 2.5 kg). It is advisable to turn the meat over during cooking, to obtain even browning on both sides. It is best to baste the meat every now and again to prevent it from drying out.

» RISING

For optimal proving of sweet or savoury dough. To maintain the quality of proving, do not activate the function if the oven is still hot following a cooking cycle.

» DEFROST

To speed up defrosting of food. Place food on the middle shelf. Leave food in its packaging to prevent it from drying out on the outside.

» KEEP WARM

For keeping just-cooked food hot and crisp.

» ECO FORCED AIR

For cooking stuffed roasting joints and fillets of meat on a single shelf. Food is prevented from drying out excessively by gentle, intermittent air circulation. When this ECO function is in use, the light will remain switched off during cooking. To use the ECO cycle and therefore optimise power consumption, the oven door should not be opened until the food is completely cooked.



CONVENTIONAL

For cooking any kind of dish on one shelf only.



GRILL

For grilling steaks, kebabs and sausages, cooking vegetables au gratin or toasting bread. When grilling meat, we recommend using a drip tray to collect the cooking juices: Position the tray on any of the levels below the wire shelf and add 500 ml of drinking water.



FAST PREHEAT

For preheating the oven quickly.



TIMERS

For editing function time values.



MINUTEMINDER

For keeping time without activating a function.



SMART CLEAN

The action of water vapor released during this special cycle of cleaning by means of a low temperature, facilitates removal of grime. Place 200 ml of drinking water on the bottom of the cavity and activate the function when the oven is cold.



FAVORITE

For retrieving the list of 10 favorite functions.



SETTINGS

For adjusting the oven settings.

When "ECO" mode is active the brightness of the display will be reduced to save energy and lamp switches off after 1 minute. It will be reactivated automatically whenever any of the buttons are pressed.

When "DEMO" is "On" all commands are active and menus available but the oven doesn't heat up. To deactivate this mode, access "DEMO" from "SETTINGS" menu and select "Off".

By selecting "FACTORY RESET", the product switches off and then it returns to first switch on. All settings will be deleted.

FIRST TIME USE

1. SELECT THE LANGUAGE

You will need to set the language and the time when you switch on the appliance for the first time: "English" will show on the display.

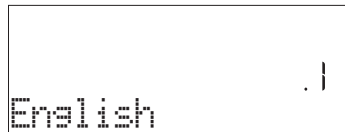

Press + or - to scroll through the list of available languages and select the one you require.

Press ✓ to confirm your selection.

Please note: The language can subsequently be changed by selecting "LANGUAGE" in "SETTINGS" menu, available by pressing ⚙️.

2. SET THE POWER CONSUMPTION

The oven is programmed to consume a level of electrical power that is compatible with a domestic network that has a rating of more than 3 kW (16): If your household uses a lower power, you will need to decrease this value (13).

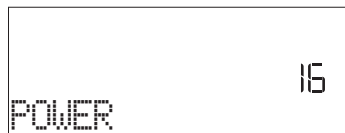

Press + or - to select 16 "High" or 13 "Low" and press ✓ to confirm.

3. SET THE TIME

After selecting the power, you will need to set the current time: The two digits for the hour will flash on the display.



Press + or - to set the current hour and press ✓: The two digits for the minutes will flash on the display.

Press + or - to set the minutes and press ✓ to confirm.

Please note: You may need to set the time again following lengthy power outages. Select "CLOCK" in "SETTINGS" menu, available by pressing ⚙️.

4. HEAT THE OVEN

A new oven may release odours that have been left behind during manufacturing: this is completely normal.

Before starting to cook food, we therefore recommend heating the oven with it empty in order to remove any possible odours. Remove any protective cardboard or transparent film from the oven and remove any accessories from inside it. Heat the oven to 200 °C for around one hour, ideally using a function with air circulation (e.g. "Forced Air" or "Convection Bake").

Please note: It is advisable to air the room after using the appliance for the first time.

DAILY USE

1. SELECT A FUNCTION

Press ⏻ to switch on the oven: the display will show the last running main function or the main menu.

The functions can be selected by pressing the icon for one of the main functions or by scrolling through a menu: To select an item from a menu (the display will show the first available item), press + or - to select the desired one, then press ✓ to confirm.

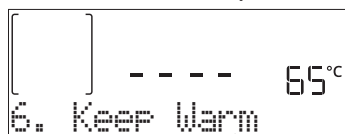

2. SET THE FUNCTION

After having selected the function you require, you can change its settings. The display will show the settings that can be changed in sequence. Pressing ⏪ allows you to change the previous setting again.

TEMPERATURE / GRILL LEVEL

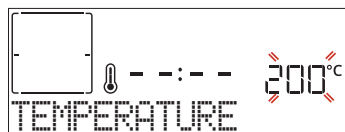

When the value flashes on the display, press + or - to change it, then press ✓ to confirm and continue with

the settings that follow (if possible).

In the same way, it is possible to set the grill level: There are three defined power levels for grilling: 3 (high), 2 (mid), 1 (low).

Please note: Once the function has been activated, the temperature/grill level can be changed using + or -.

DURATION

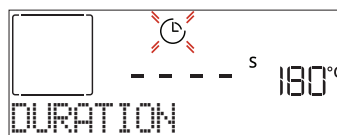

When the ⌚ icon flashes on the display, press + or - to set the cooking time you require and then press ✓ to confirm. You do not have to set the cooking time if you want to manage cooking manually (untimed): Press ✓ or ▶ to confirm and start the function. By selecting this mode, you cannot program a delayed start.

Please note: You can adjust the cooking time that has been set during cooking by pressing ⌚: press + or - to amend it and then press ✓ to confirm.

END TIME (START DELAY)

In many functions, once you have set a cooking time you can delay starting the function by programming its end time. The display shows the end time while the  icon flashes.



Press **+** or **-** to set the time you want cooking to end, then press **✓** to confirm and activate the function. Place the food in the oven and close the door: The function will start automatically after the period of time that has been calculated in order for cooking to finish at the time you have set.

Please note: Programming a delayed cooking start time will disable the oven preheating phase: The oven will reach the temperature you require gradually, meaning that cooking times will be slightly longer than those listed in the cooking table. During the waiting time, you can press **+** or **-** to amend the programmed end time or press **<<** to change other settings. By pressing , in order to visualize information, it is possible to switch between end time and duration.

6th SENSE

These functions automatically select the best cooking mode, temperature and duration to cook, roast or bake all the dishes available.

When required, simply indicate the characteristic of food to obtain an optimal result.

WEIGHT / HEIGHT (ROUND-TRAY-LAYERS)



To set the function correctly, follow the indications on the display, when prompted, and press **+** or **-** to set the required value then press **✓** to confirm.

DONENESS / BROWNING

In some 6th Sense functions it is possible to adjust the doneness level.

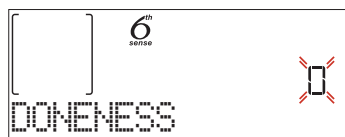

When prompted, press **+** or **-** to select the desired level between rare (-1) and well done (+1). Press **✓** or  to confirm and start the function.

In the same way, where allowed, in some 6th Sense functions, it's possible to adjust the browning level between low (-1) and high (+1).

3. START THE FUNCTION

At any time, if the default values are those desired or once you have applied the settings you require, press  to activate the function.

During the delay phase, by pressing  the oven will ask if you want to skip this phase, starting immediately

the function.

Please note: Once a function has been selected, the display will recommend the most suitable level for each function. At any time you can stop the function that has been activated by pressing .

If the oven is hot and the function requires a specific maximum temperature, a message will shown on the display. Press **<<** to return to previous screen and select a different function or wait for a complete cooling.

4. PREHEATING

Some functions have an oven preheating phase: Once the function has started, the display indicates that the preheating phase has been activated.

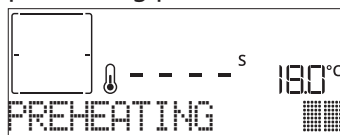

Once this phase has finished, an audible signal will sound and the display will indicate that the oven has reached the set temperature, requiring to "ADD FOOD". At this point, open the door, place the food in the oven, close the door and start cooking by pressing **✓** or .

Please note: Placing the food in the oven before preheating has finished may have an adverse effect on the final cooking result. Opening the door during the preheating phase will stop pause it.

The cooking time does not include a preheating phase. You can always change the temperature you want the oven to reach using **+** or **-**.

5. PAUSE COOKING / TURN OR CHECK FOOD

By opening the door, the cooking will be temporarily paused through deactivating heating elements.

To resume the cooking, close the door.

Some 6th Sense functions will require the food to be turned during cooking.



An audible signal will sound and the display shows the action to be done. Open the door, do the action prompted by the display and close the door, then press  to continue cooking.

In the same way, at 10% of time before the end of cooking, the oven prompts you to check the food.



An audible signal will sound and the display shows the action to be done. Check the food, close the door and press  or **✓** to continue cooking.

Please note: Press  to skip these actions. Otherwise, if no action is done after a certain time the oven will continue the cooking.

6. END OF COOKING

An audible signal will sound and the display will indicate that cooking is complete.

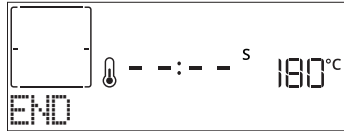

Press to continue cooking in manual mode (untimed) or press to extend the cooking time by setting a new duration. In both cases, the cooking parameters will be retained.

BROWNING

Some functions of the oven enable you to brown the surface of the food by activating the grill once cooking is complete.

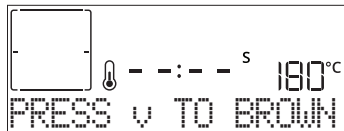

When the display shows the relevant message, if required press to start a five-minute browning cycle. You can stop the function at any time by pressing to switch the oven off.

FAVORITES

Once cooking is complete the display will prompt you to save the function in a number between 1 and 10 on your list of favorites.



If you would like to save a function as a favorite and store the current settings for future use, press otherwise, to ignore the request press .

Once has been pressed, press the or to select the number position, then press to confirm.

Please note: If the memory is full or the number chosen has already been taken, the oven will ask you to confirm overwriting the previous function.

To call up the functions you have saved at a later time, press : The display will show your list of favorite functions.



Press or to select the function, confirm by pressing , and then press to activate.

SMARTCLEAN FUNCTION

Press to show "Smart Clean" on the display.

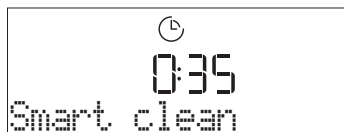

Press to activate the function: the display will prompt you to do all actions needed to obtain the best

cleaning results: Follow the indications and then press when done. Once you have done all steps, when required press to activate the cleaning cycle.

Please note: It is recommended to do not open the oven door during the cleaning cycle to avoid a loss of water vapor that could get an adverse effect on the final cleaning result.

An appropriate message will start flashing on the display once the cycle has finished. Leave the oven to cool and then wipe and dry the interior surfaces with a cloth or sponge.

MINUTEMINDER

When the oven is switched off, the display can be used as a timer. To activate this function, make sure that the oven is switched off and press or : The icon will flash on the display.



Press or to set the length of time you require and then press to activate the timer.



An audible signal will sound and the display will indicate once the minuteminder has finished counting down the selected time.

Please note: The minuteminder does not activate any of the cooking cycles. Press or to change the time set on the timer.

Once the minuteminder has been activated, you can also select and activate a function.

Press to switch on the oven and then select the function you require.

Once the function has started, the timer will continue to count down independently without interfering with the function itself.

Please note: During this phase, it isn't possible to see the minuteminder (only the icon will be displayed), that will continue counting down in background. To retrieve the minuteminder screen press to stop the function that is currently active.





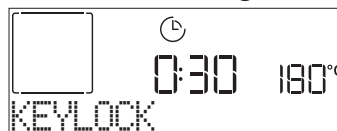











































KEYLOCK

To lock the keypad, press and hold for at least five seconds. Do this again to unlock the keypad.



Please note: This function can also be activated during cooking. For safety reasons, the oven can be switched off at any time by pressing .

6th
sense **COOKING TABLE**

FOOD CATEGORIES		SUGGESTED QUANTITY	TURN OR STIR (OF COOK TIME)	LEVEL AND ACCESSORIES	
CASSEROLE & BAKED PASTA	Lasagna	-	0.5 - 3 kg	-	2 
	Beef-roasted	Roast (doneness 0)	0.6 - 2 kg	-	3 
Hamburgers (doneness 0)		1.5 - 3 cm	3/5	5 4  	
MEAT	Pork-roasted	Roast	0.6 - 2.5 kg	-	3 
		Sausages & wurstel	1.5 - 4 cm	2/3	5 4  
Chicken-roasted	Whole	0.6 - 3 kg	-	2 	
	Fillet & breast	1 - 5 cm	2/3	5 4  	
Kebabs	-	1 grid	1/2	5 4  	
FISH	Fillets	-	0.5 - 3 cm	-	3 2  
	Fillets-frozen	-	0.5 - 3 cm	-	3 2  
VEGETABLES	Vegetables-roasted	Potatoes	0.5 - 1.5 kg	-	3 
		Vegetables-stuffed	0.1 - 0.5 kg each	-	3 
		Vegetables-roasted	0.5 - 1.5 kg	-	3 
	Vegetables-gratin	Potatoes	1 tray	-	3 
		Tomatoes	1 tray	-	3 
		Peppers	1 tray	-	3 
		Broccoli	1 tray	-	3 
		Cauliflowers	1 tray	-	3 
Others	1 tray	-	3 		
CAKES & PASTRIES	Rising cakes in tin	Sponge Cake	0.5 - 1.2 kg	-	3 
		Cookies	0.2 - 0.6 kg	-	5 
	Pastries & filled pies	Choux pastry	1 tray	-	5 
		Tart	0.4 - 1.6kg	-	3 
		Strudel	0.4 - 1.6kg	-	5 
		Fruit filled pie	0.5 - 2 kg	-	3 
SALT CAKES	-	0.8 - 1.2 kg	-	2 	
BREAD	Rolls	-	60 - 150 g each	-	3 
	Sandwich Loaf in tin	-	400 - 600g each	-	2 
	Big bread	-	0.5 - 2.0 kg	-	2 
	Baguettes	-	200 - 300g each	-	3 
PIZZA	Thin	-	round - tray	-	2 
	Thick	-	round - tray	-	2 
	Frozen	-	-	-	2 
		1 - 4 layers	-	-	4 2  
-	-	-	-	5 3 1   	
-	-	-	-	5 3 2 1    	

ACCESSORIES

 Wire shelf

























































































 Oven tray or cake tin
 on wire shelf

 Drip tray / Baking tray
 or oven tray on wire shelf

 Drip tray / Baking tray

 Drip tray with
 500 ml of water

COOKING TABLE

RECIPE	FUNCTION	PREHEAT	TEMPERATURE (°C)	DURATION (MIN.)	SHELF AND ACCESSORIES
Leavened cakes / Sponge cakes		Yes	170	30 - 50	
		Yes	160	30 - 50	
		Yes	160	30 - 50	 
Filled cakes (cheesecake, strudel, apple pie)		Yes	160 - 200	30 - 85	
		Yes	160 - 200	35 - 90	 
Cookies		Yes	150	20 - 40	
		Yes	140	30 - 50	
		Yes	140	30 - 50	 
		Yes	135	40 - 60	  
Small cakes / Muffin		Yes	170	20 - 40	
		Yes	150	30 - 50	
		Yes	150	30 - 50	 
		Yes	150	40 - 60	  
Choux buns		Yes	180 - 200	30 - 40	
		Yes	180 - 190	35 - 45	 
		Yes	180 - 190	35 - 45 *	  
Meringues		Yes	90	110 - 150	
		Yes	90	130 - 150	 
		Yes	90	140 - 160 *	  
Pizza / Bread / Focaccia		Yes	190 - 250	15 - 50	
		Yes	190 - 230	20 - 50	 
Pizza (Thin, thick, focaccia)		Yes	220 - 240	25 - 50 *	  
Frozen pizza		Yes	250	10 - 15	
		Yes	250	10 - 20	 
		Yes	220 - 240	15 - 30	  
Savoury pies (vegetable pie, quiche)		Yes	180 - 190	45 - 55	
		Yes	180 - 190	45 - 60	 
		Yes	180 - 190	45 - 70 *	  
Vols-au-vent / Puff pastry crackers		Yes	190 - 200	20 - 30	
		Yes	180 - 190	20 - 40	 
		Yes	180 - 190	20 - 40 *	  

FUNCTIONS



Conventional



Forced air



Convection
bake



Grill



TurboGrill



MaxiCooking



Cook 4



Eco Forced air

RECIPE	FUNCTION	PREHEAT	TEMPERATURE (°C)	DURATION (MIN.)	SHELF AND ACCESSORIES
Lasagna / Flans / Baked pasta / Cannelloni		Yes	190 - 200	45 - 65	3
Lamb / Veal / Beef / Pork 1 kg		Yes	190 - 200	80 - 110	3
Roast pork with crackling 2 kg		—	170	110 - 150	2
Chicken / Rabbit / Duck 1 kg		Yes	200 - 230	50 - 100	3
Turkey / Goose 3 kg		Yes	190 - 200	80 - 130	2
Baked fish / en papillote (fillets, whole)		—	180 - 200	40 - 60	3
Stuffed vegetables (tomatoes, courgettes, aubergines)		Yes	180 - 200	50 - 60	2
Toast		—	3 (High)	3 - 6	5
Fish fillets / Steaks		—	2 (Mid)	20 - 30 ***	4 3
Sausages / Kebabs / Spare ribs / Hamburgers		—	2 - 3 (Mid - High)	15 - 30 ***	5 4
Roast chicken 1-1.3 kg		—	2 (Mid)	55 - 70 **	2 1
Leg of lamb / Shanks		—	2 (Mid)	60 - 90 **	3
Roast potatoes		—	2 (Mid)	35 - 55 **	3
Vegetable gratin		—	3 (High)	10 - 25	3
Cookies	Cookies	Yes	135	50 - 70	5 4 3 1
Tarts	Tarts	Yes	170	50 - 70	5 3 2 1
Round pizzas	Pizza	Yes	210	40 - 60	5 3 2 1
Complete meal: Fruit tart (level 5) / lasagna (level 3) / meat (level 1)		Yes	190	40 - 120 *	5 3 1
Complete meal: Fruit tart (level 5) / roasted vegetables (level 4) / lasagna (level 2) / cuts of meat (level 1)	Menu	Yes	190	40 - 120 *	5 4 2 1
Lasagna & Meat		Yes	200	50 - 100 *	4 1
Meat & Potatoes		Yes	200	45 - 100 *	4 1
Fish & Vegetables		Yes	180	30 - 50 *	4 1
Stuffed roasting joints		—	200	80 - 120 *	3
Cuts of meat (rabbit, chicken, lamb)		—	200	50 - 100 *	3

* Estimated length of time: dishes can be removed from the oven at different times depending on personal preference.

** Turn food halfway through cooking.

*** Turn food two thirds of the way through cooking (if necessary).

ACCESSORIES

Wire shelf

Oven tray or cake tin on wire shelf

Drip tray / Baking tray on oven tray on wire shelf

Drip tray / Baking tray

Drip tray with 500 ml of water

CLEANING AND MAINTENANCE

Make sure that the oven has cooled down before carrying out any maintenance or cleaning. Do not use steam cleaners.

Do not use wire wool, abrasive scourers or abrasive/corrosive cleaning agents, as these could damage the surfaces of the appliance.

Wear protective gloves. The oven must be disconnected from the mains before carrying out any kind of maintenance work.

EXTERIOR SURFACES

- Clean the surfaces with a damp microfibre cloth. If they are very dirty, add a few drops of pH-neutral detergent. Finish off with a dry cloth.
- Do not use corrosive or abrasive detergents. If any of these products inadvertently comes into contact with the surfaces of the appliance, clean immediately with a damp microfibre cloth.

INTERIOR SURFACES

- After every use, leave the oven to cool and then clean it, preferably while it is still warm, to remove any deposits or stains caused by food residues. To dry any condensation that has formed as a result of cooking foods with a high water content, let the oven to cool completely and then wipe it with a cloth or sponge.

- Activate the “Smart Clean” function for optimum cleaning of the internal surfaces. (Only in some models).
- Clean the glass in the door with a suitable liquid detergent.
- The oven door can be removed to facilitate cleaning.

ACCESSORIES

Soak the accessories in a washing-up liquid solution after use, handling them with oven gloves if they are still hot. Food residues can be removed using a washing-up brush or a sponge.

CLEANING THE CATALYTIC PANELS (ONLY IN SOME MODELS)

This oven could be equipped with special catalytic liners that facilitate cleaning of the cooking compartment thanks to their special self-cleaning coating, which is highly porous and able to absorb grease and grime. These panels are fitted to the shelf guides: When repositioning and then refitting the shelf guides, make sure that the hooks at the top are slotted into the appropriate holes in the panels.

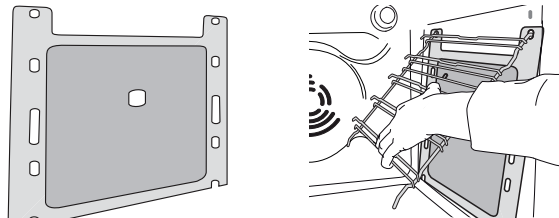

To make best use of the catalytic panels' self-cleaning properties, we recommend heating the oven to 200 °C for around one hour using the “Convection Bake” function. The oven must be empty during this time. Then leave the oven to cool down before removing any remaining food residues using a non-abrasive sponge.

Please note: Using corrosive or abrasive cleaning agents, stiff brushes, pan scourers or oven sprays could damage the catalytic surface and compromise its self-cleaning properties. Please contact our After-sales Service if you require replacement panels.

REPLACING THE LAMP

1. Disconnect the oven from the power supply.
2. Unscrew the cover from the light, replace the bulb and screw the cover back on the light.
3. Reconnect the oven to the power supply.

Please note: Only use 20-40 W/230 ~ V type G9, T300°C halogen bulbs. The bulb used in the product is specifically designed for domestic appliances and is not suitable for general room lighting within the home (EC Regulation 244/2009). Light bulbs are available from our After-sales Service.

- If using halogen bulbs, do not handle them with your bare hands as your fingerprints could cause damage. Do not use the oven until the light cover has been refitted.

LOWER THE TOP HEATING ELEMENT (ONLY IN SOME MODELS)

1. Remove the lateral shelf guides.

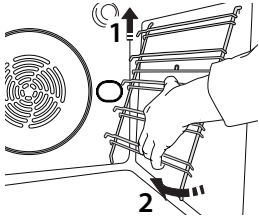

2. Pull the heating element out a little and lower it.

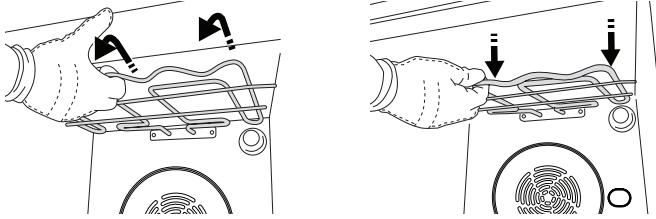

3. To reposition the heating element, lift it up, pulling it slightly towards you, making sure it comes to rest on the lateral supports.

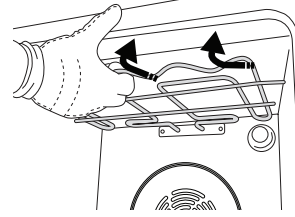

REMOVING AND REFITTING THE DOOR

1. To remove the door, open it fully and lower the catches until they are in the unlock position.

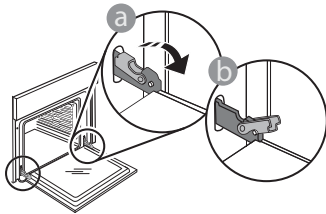

2. Close the door as much as you can. Take a firm hold of the door with both hands – do not hold it by the handle.

Simply remove the door by continuing to close it while pulling it upwards at the same time until it is released from its seating. Put the door to one side, resting it on a soft surface.

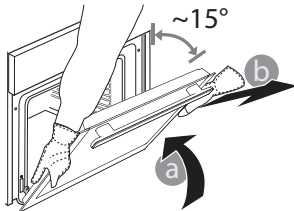

3. Refit the door by moving it towards the oven, aligning the hooks of the hinges with their seating and securing the upper part onto its seating.
4. Lower the door and then open it fully. Lower the catches into their original position: Make sure that you lower them down completely.

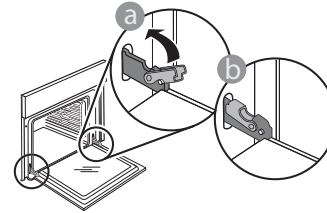

Apply gentle pressure to check that the catches are in the correct position.

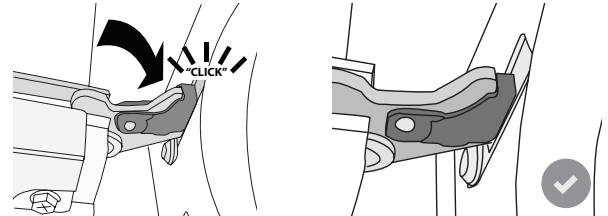

5. Try closing the door and check to make sure that it lines up with the control panel. If it does not, repeat the steps above: The door could become damaged if it does not work properly.

TROUBLESHOOTING

PROBLEM	POSSIBLE CAUSE	SOLUTION
The oven is not working.	Power cut. Disconnection from the mains.	Check for the presence of mains electrical power and whether the oven is connected to the electricity supply. Turn off the oven and restart it to see if the fault persists.
The display shows the letter "F" followed by a number or letter.	Oven failure.	Contact your nearest Client After-sales Service Centre and state the number following the letter "F".
The oven does not heat up. The function does not start.	"DEMO" mode is running.	Access "DEMO" from "SETTINGS" and select "Off".
The light switches off.	"ECO" mode is "On".	Access "ECO" from "SETTINGS" and select "Off".
The door will not close properly.	The safety catches are in the wrong position.	Make sure that the safety catches are in the correct position by following the instructions for removing and refitting the door in the "Cleaning and Maintenance" section.

PRODUCT FICHE

 [www](http://www.docs.whirlpool.eu) The product fiche with energy data of this appliance can be downloaded from Whirlpool website docs.whirlpool.eu

HOW TO OBTAIN THE USE AND CARE GUIDE

>  [www](http://www.docs.whirlpool.eu) Download the Use and Care Guide from our website docs.whirlpool.eu (you can use this QR Code), specifying the product's commercial code.



> Alternatively, contact our Client After-sales Service.

CONTACTING OUR AFTER-SALES SERVICE

You can find our contact details in the warranty manual. When contacting our Client After-sales Service, please state the codes provided on your product's identification plate.

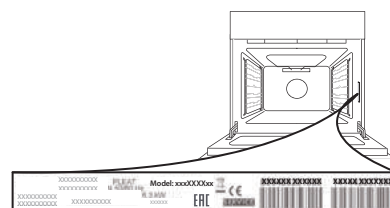

400011349720

Printed in Italy